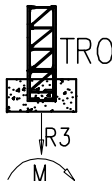
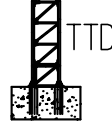
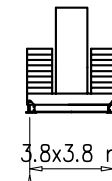

Torre/Reazioni – Masts/Reactions – Mat/Réactions – Maste/Eckdrücke – Mästil/Reacciones – Tramo/Reacções

SG1200

 20 m \rightarrow 55 m

Torre/Masts/Mat/Maste/Mästil/Tramo							
 TR0	H[m]	BL060	B0060	B0120	ST030	ST060	ST120
	 TTD	30	2f/2f	2f/3f	2f/3f	3f/3f	3f/3f
	24	1	1			2	
	30			1		3	

Torre/Masts/Mat/Maste/Mästil/Tramo							
 CAF	H[m]	BL060	B0060	B0120	ST030	ST060	ST120
		30	2f/2f	2f/3f	2f/3f	3f/3f	3f/3f
	24	1	1			2	
	30			1		3	

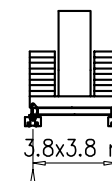
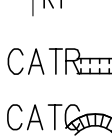
Torre/Masts/Mat/Maste/Mästil/Tramo							
 CATR	H[m]	BL060	B0060	B0120	ST030	ST060	ST120
	 CATC	24	1	1			
	24	1	1			2	
	18	1	1			1	
	18			1		1	
	21	1	1		1	1	

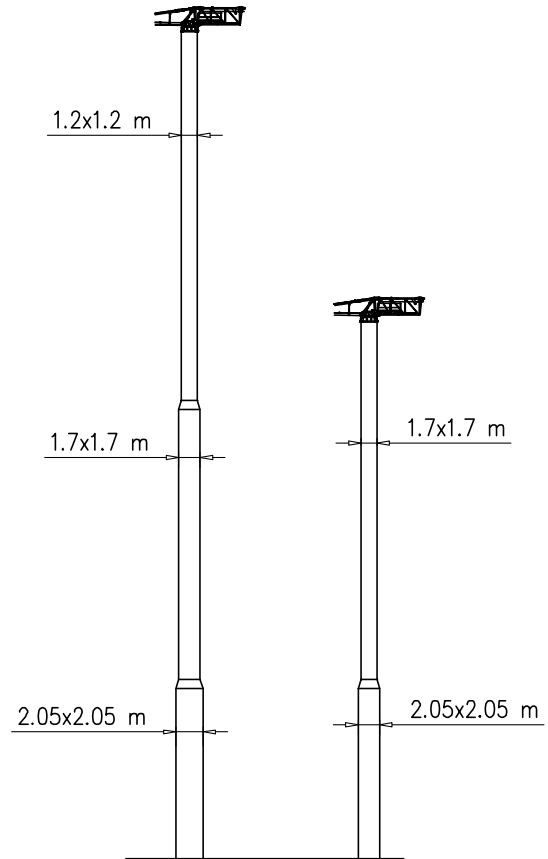

H=0–15 m	
R1	53 t
R2	53 t
R3	25.6 t
M	116 tm

H=16–30 m	
R1	69 t
R2	69 t
R3	40 t
M	185 tm

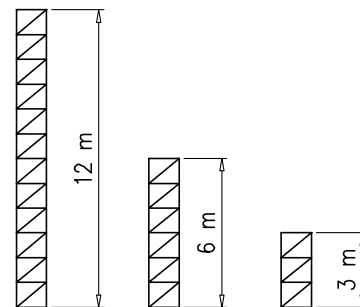

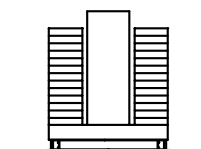

Peso zavorra – Ballast weight – Poids du lest – Ballastgewicht – Peso de lastre



H	Tot.
0–15 m	54000 kg
16–30 m	72000 kg

Torre/Reazioni – Masts/Reactions – Mat/Réactions – Maste/Eckdrücke – Măstil/Reacciones – Tramo/Reacções

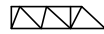
SK1700

 20 m —  55 m

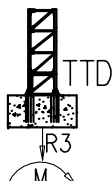
		Torre/Masts/Mat/Maste/Măstil/Tramo														
		H[m]	4f/4f BF117	4f/4f BF052	4f/4f BF039	4f/2f SB117	4f/2f SB052	4f/2f SB039	2f/2f ST117	2f/2f ST052	2f/2f ST039	2f/2f STB117	2f/2f STB039	2f/2f RA039	4f/2f SBB039	4f/2f SBB117
		54.6							4		2					
		52								10						
		35.1								3						
*		52											11	1		
*		52										1	8	1		

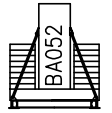
		Torre/Masts/Mat/Maste/Măstil/Tramo														
		H[m]	4f/4f BF117	4f/4f BF052	4f/4f BF039	4f/2f SB117	4f/2f SB052	4f/2f SB039	2f/2f ST117	2f/2f ST052	2f/2f ST039	2f/2f STB117	2f/2f STB039	2f/2f RA039	4f/2f SBB039	4f/2f SBB117
		59.8							4		2					
		59.8								9	2					
		40.3							3							
*		52											11	1		
*		52										1	8	1		

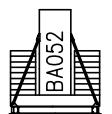
		Torre/Masts/Mat/Maste/Măstil/Tramo														
		H[m]	4f/4f BF117	4f/4f BF052	4f/4f BF039	4f/2f SB117	4f/2f SB052	4f/2f SB039	2f/2f ST117	2f/2f ST052	2f/2f ST039	2f/2f STB117	2f/2f STB039	2f/2f RA039	4f/2f SBB039	4f/2f SBB117
		52							4							
		52								9						
		40.3							3							
*		52											11	1		
*		52										1	8	1		

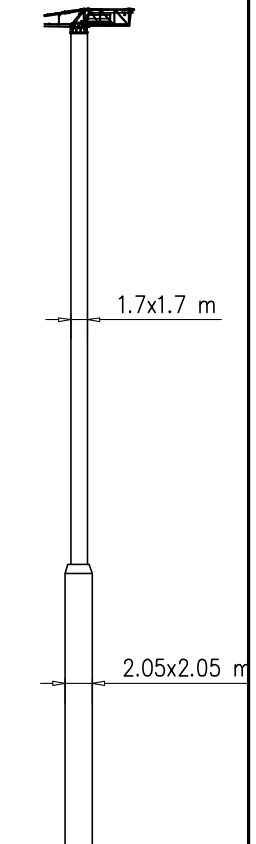

H=0-35 m
R1 65 t
R2 65 t
R3 54 t
M 156 tm

H=36-45 m
R1 72 t
R2 72 t
R3 61 t
M 194 tm

H=46-60 m
R1 106 t
R2 106 t
R3 95 t
M 336 tm





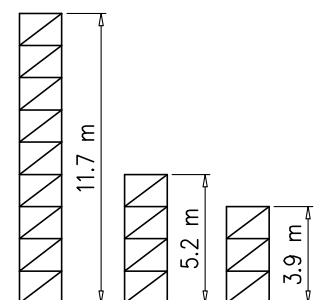







Peso zavorra—Ballast weight—Poids du lest
Ballastgewicht—Peso de lastre

H	n°	Tot.
0-35 m	2C+ 18D	60800 kg
36-45 m	2C+ 22D	72000 kg
46-60 m	2C+ 34D	105550 kg















Curve di carico – Courbes de charges – Load diagrams – LastKurven – Curvas de cargas

Pmax 3000 kg

	16800 kg		2	30	32.5	35	37.5	40	42.5	45	47.5	50	52.5	55	m	
		55 m	3000	3000	2750	2510	2310	2120	1970	1850	1690	1580	1450	1300	kg	
	14400 kg		2	31	32.5	35	37.5	40	42.5	45	47.5	50	m			
		50 m	3000	3000	2960	2700	2480	2290	2120	1970	1830	1600	kg			
	12000 kg		2	34	35	37.5	40	42.5	45	m						
		45 m	3000	3000	2940	2720	2500	2300	2000	kg						
	10800 kg		2					37.5	40	m						
		40 m	3000					3000	2600	kg						
	10800 kg		2						35	m						
		35 m	3000						3000	kg						
	9600 kg		2	30	m											
		30 m	3000	3000	kg											









Pmax 6000/3000 kg





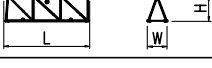
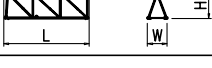
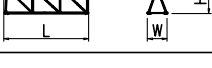
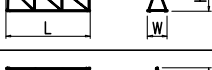
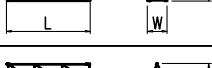
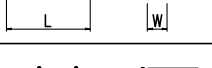
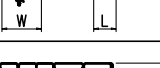
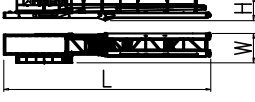
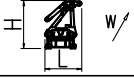
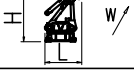
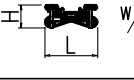
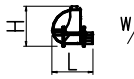

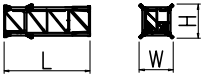



	16800 kg		2	16.5	17.5	20	22.5	25	27.5	30	32.5	35	37.5	40	42.5	45	47.5	50	52.5	55	m
		55 m	6000	6000	5640	4850	4250	3760	3370	3000	2750	2510	2310	2120	1970	1850	1690	1580	1450	1300	kg
	14400 kg		2	17.5		20	22.5	25	27.5	30	32.5	35	37.5	40	42.5	45	47.5	50	m		
		50 m	6000	6000		5200	4550	4030	3610	3250	2960	2700	2480	2290	2120	1970	1830	1600	kg		
	12000 kg		2	19	20	22.5	25	27.5	30	32.5	35	37.5	40	42.5	45	m					
		45 m	6000	6000	5600	4920	4350	3900	3530	3210	2940	2720	2500	2300	2000	kg					
	10800 kg		2	21		22.5	25	27.5	30	32.5	35	37.5	40	m							
		40 m	6000	6000		5480	4860	4370	3950	3600	3300	3000	2600	kg							
	10800 kg		2	22		25	27.5	30	32.5	35	m										
		35 m	6000	6000		5250	4740	4260	3900	3300	kg										
	9600 kg		2	24			25	27.5	30	m											
		30 m	6000	6000			5700	5000	4300	kg											



PESI E INGOMBRI – PACKING LIST – LISTE DE COLISAGE – GEWICHT UND ABMESSUNGEN

Denominazione Description	Disegno Draw	Pezzi Pieces	Dimensioni-Dimensions (mm)			Peso-Weight (kg)			
			L	W	H	Unit	Total		
Elemento di braccio Jib element Elément de èche Elemento de flecha	n°11		1	5500	1480	2290	1500	–	
	n°10		1	5260	1200	2150	980	–	
	n°9		1	5260	1200	2120	800	–	
	n°8		1	5240	1200	2100	700	–	
	n°7		1	5225	1200	2060	635	–	
	n°6		1	5200	1200	1630	500	–	
	n°5		1	5160	1200	1630	370	–	
	n°4		1	5140	1200	1610	350	–	
	n°3		1	5110	1200	1610	250	–	
	n°2		1	5090	1200	1260	210	–	
	n°1		1	5090	1200	1260	200	–	
	Punta braccio		1	700	1200	500	55	–	
Controbraccio completo Complete counterjib Contreflèche complète Contraflecha completa		1	10660	1750	1480	2900	–		
Gruppo girevole Slewing group Table tournante Grupo giratorio	SK1700		1	2300	1810	2900	5900	–	
	S1200		1	2450	1810	2900	3500	–	
Carrello Trolley Chariot Carretilla	P6		1	1600	1620	710	320	–	
Ballatoio con cabina Access balcony with cabin Porte cabine Balcòn corrido con cabina			1	2500	2150	2450	1000	–	
Blocchi contrappeso Counterweight block Contre-poids Bloques de contrapeso	VX24		VS12	2	1000	200	2500	1200	2400
	VS12			6	1000	400	2500	2400	14400
Elemento di base Base element Mat de base Elemento de base	BA052		1	5200	2060	2060	3650	–	

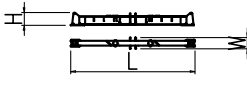
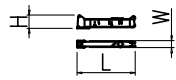
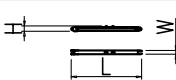
PESI E INGOMBRI – PACKING LIST – LISTE DE COLISAGE – GEWICHT UND ABMESSUNGEN

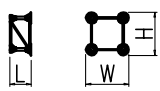
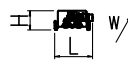
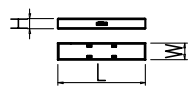
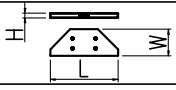
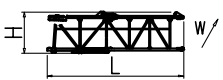
Denominazione Description	Disegno Draw	Pezzi Pieces	Dimensioni-Dimensions (mm)			Peso-Weight (kg)		
			L	W	H	Unit	Total	
Elemento di torre Mast element Elément de mature Elemento de torre	 STD039	SK1700	–	3900	1785	1785	1750	–
	 STD052	SK1700	–	5200	1785	1785	2250	–
	 STD117	SK1700	–	11700	1785	1785	4690	–
	 BL060	SG1200	–	6000	1440	1440	2162	–
	 B0060	SG1200	–	6000	1440	1440	2035	–
	 B0120	SG1200	–	12000	1440	1440	3670	–
	 ST030	SG1200	–	3000	1200	1200	934	–
	 ST060	SG1200	–	6000	1200	1200	1635	–
	 ST120	SG1200	–	12000	1200	1200	3060	–
Carro di base Base carriage Chassis de base Cruceta de base		3.8x3.8	1	5700	520	660	2280	2280
		4.5x4.5	1	6670	670	780	2040	2040
		5x5	1	7550	670	780	2300	2300
		3.8x3.8	2	2700	340	660	1090	2180
		4.5x4.5	2	3180	420	780	980	1960
		5x5	2	3530	420	780	1060	2120
Puntoni di base Rafters Jambes de force Cabrios de base		4.5x4.5	4	4070	240	300	270	1080
		5x5	4	4250	240	300	280	1120
Elemento a perdere Disposable frame Chassis a perdre Bastidor desechable		SG1200	1	1990	1440	1440	1150	–
		SK1700	1	1840	1910	1910	1430	–
Elemento recuperabile Recoverable frame Chassis récupérable Bastidor recuperable		SG1200	1	600	1740	1740	940	–
		SK1700	1	1300	2170	2170	1720	–
Bogie di traslazione Driven bogie Boggie motorisée Balancin de traslaciòn			4	1160	700	600	700	2800
Blocco zavorra di base Base ballast block Lest de base Brique de lastre		3.8x3.8	–	4000	1200	270	3000	–
		4.5x4.5	2	5000	750	600	5175	10350
		5x5	2	5300	1000	600	7300	14600
		4.5x4.5	–	3600	1450	300	2800	–
		5x5	–	4100	1600	300	3500	–
Corsoio di montaggio Climbing cage Cage de montage Jaula de montaje		SG1200	1	8300	1600	1500	3000	–
		SK1700	1	8300	2600	2500	6000	–

GRU IN CAVEDIO – TELESCOPAGE SUR DALLES – CLIMBING CRANE – KLETTERKRANE IM GEBAUDE

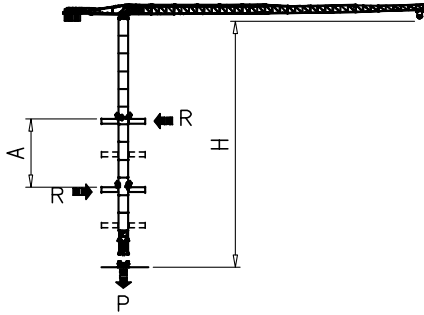

SN2050	H (m)	A (m)	R (t)	P (t)
	9	45.3		
	10	42		
	11	39.3		
	12	37		
	13	35		
	14	33.4		
	15	32		
	16	30.7		
	17	29.6		
	18	28.6		
<p>Apertura passaggio gru Opening for crane passing</p>	19	27.8		
	20	27		

* SOPRALZO IDRAULICO – TELESCOPABLE – EXTERNAL CLIMBING – KLETTERKRANE

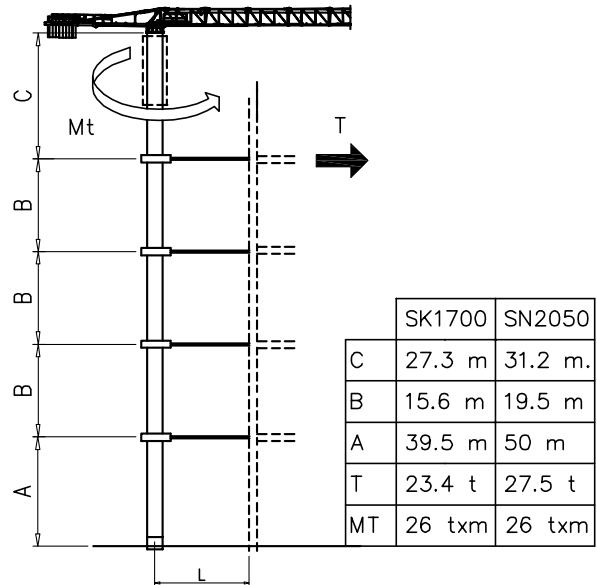
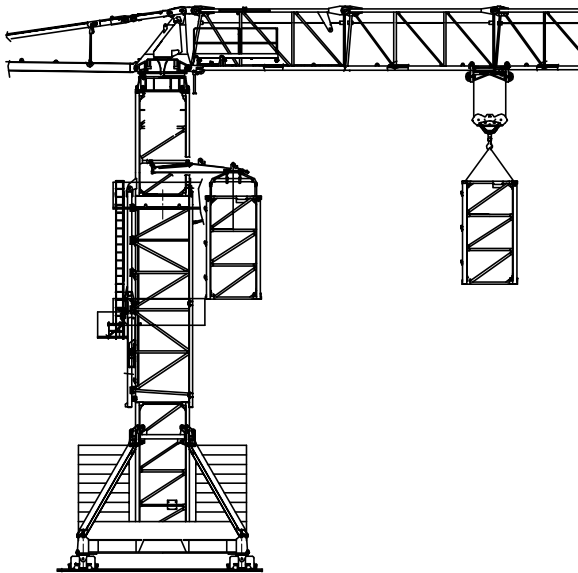

Montaggio – Montage – Erection – Montage – Montaje – Montagem

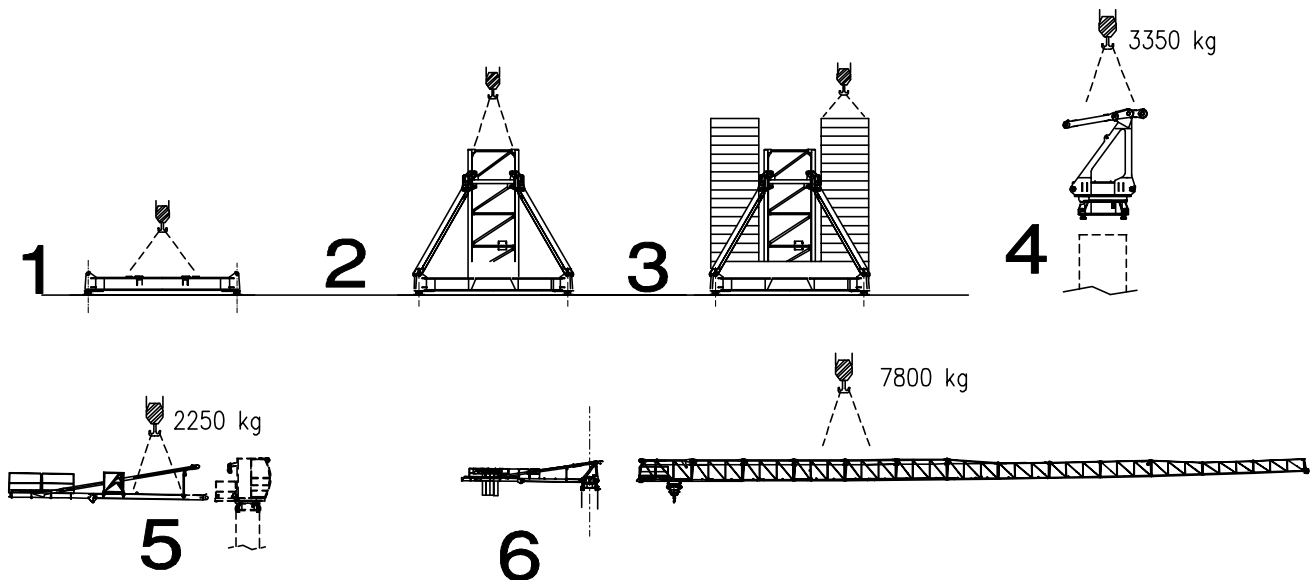

Sollevamento V25.60 Hoisting Levage Heben Elevaciòn Elevaçao														V25.60 18.4 kW 37 kVA 172 m
	m/min	7	18	28	42	56	65	3.5	9	14	21	28	32.5	
	t	3	3	3	2.25	1.5	0.9	6	6	6	4.5	3	1.8	

Sollevamento V33.90 Hoisting Levage Heben Elevaciòn Elevaçao														V33.90 22 kW 47 kVA 380 m
	m/min	3	18	34	54	70	90	1.5	9	17	27	35	45	
	t	3	3	3	1.8	1.3	0.5	6	6	6	3.6	2.6	1	

Carrello Trolleying Distribution Katzfahren Distribuciòn Distribuiçao			0 → 80	m/min	3 kW	Potenza elettrica necessaria Puissance électrique nécessaire Necessary electric power Anschlusswert – Potencia
Rotazione Slewing Orientation Schwenken Orientaciòn Rotaçao			0 → 0,9	giri/min tr/min rp/min	4.4 kW @ 1200rpm n° 2 x 2.2 kW	
Traslazione Travelling Translation Kranfahren Traslaciòn Traslaçao			0 → 20	m/min	3.7 kW	

Rete elettrica – Réseau – Mains supply – Netzstrom – Red – Rede electrica	400V – 50 Hz
---	--------------

FMgru s.r.l. via Emilia 11–29010 Pontenure PC ITALY tel. 0523/510446 ric.aut. fax 0523/510365 www.fmgru.it e-mail: info@fmgru.com
--

FEM 1.001 2000/14/CE



Documento commerciale non contrattuale
Per tutte le informazioni tecniche riferirsi
alle corrispondenti istruzioni

Unverbindliches Vertriebsdokument.
Für technische Informationen, siehe die
entsprechenden Anweisungen.

This commercial document is not legally
binding. For any technical information, please
refer to the corresponding instructions.

Documento comercial non contractual
Para cualquier información técnica,
ver la noticia correspondiente.

Code: 15ICA37T35A0		
Ed.	Data	Rev Data
1	26.04.01	2 26.04.10